

CORSA UTILE

A

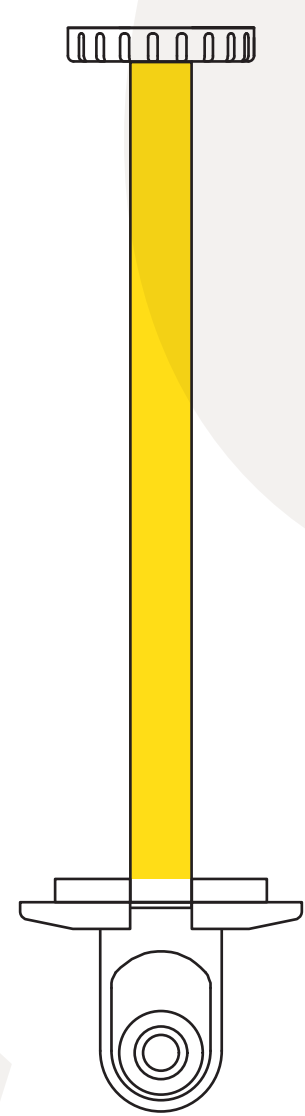

6"
152,4 mm

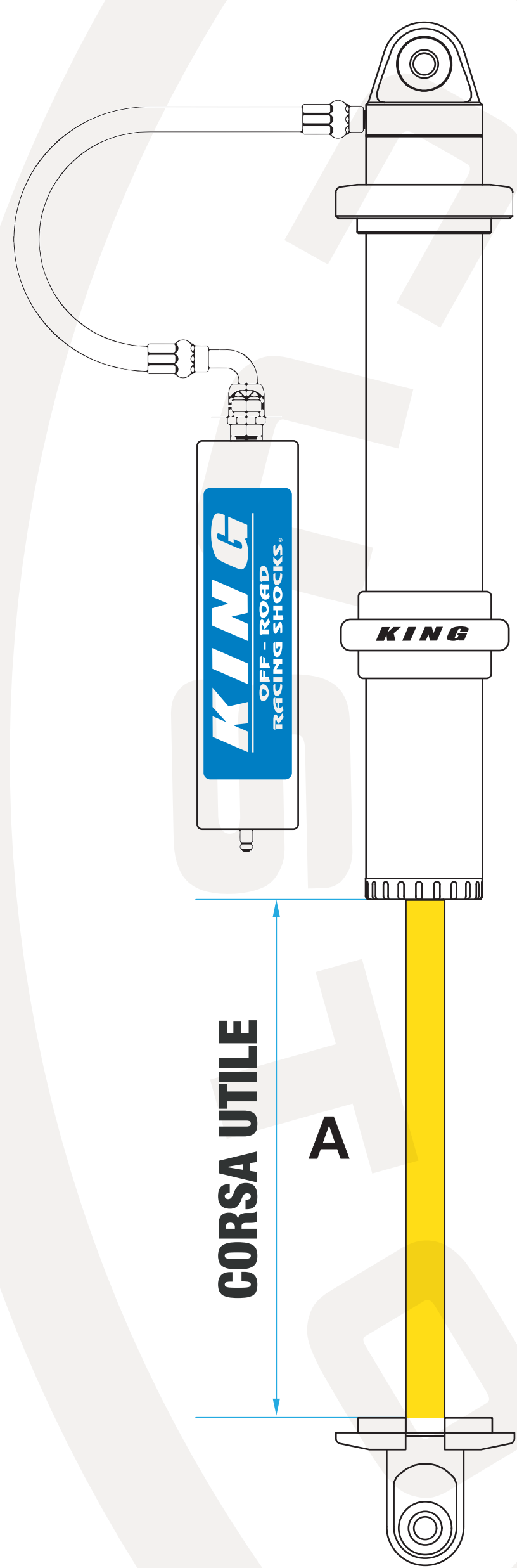
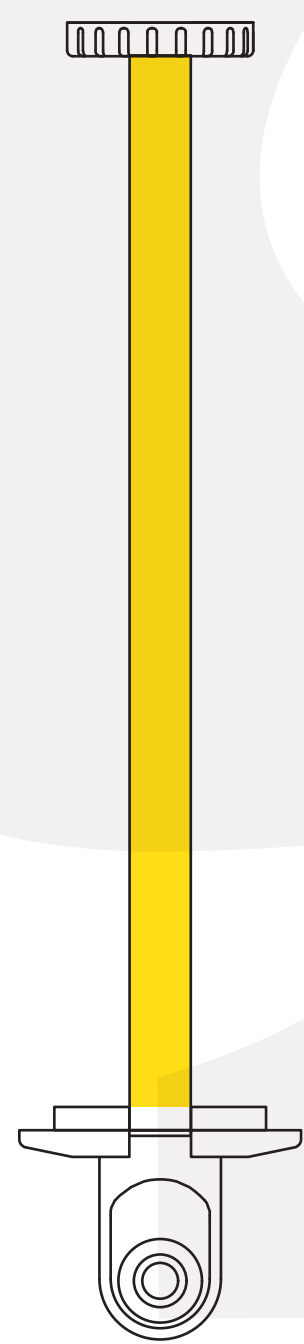

8"
203,2 mm

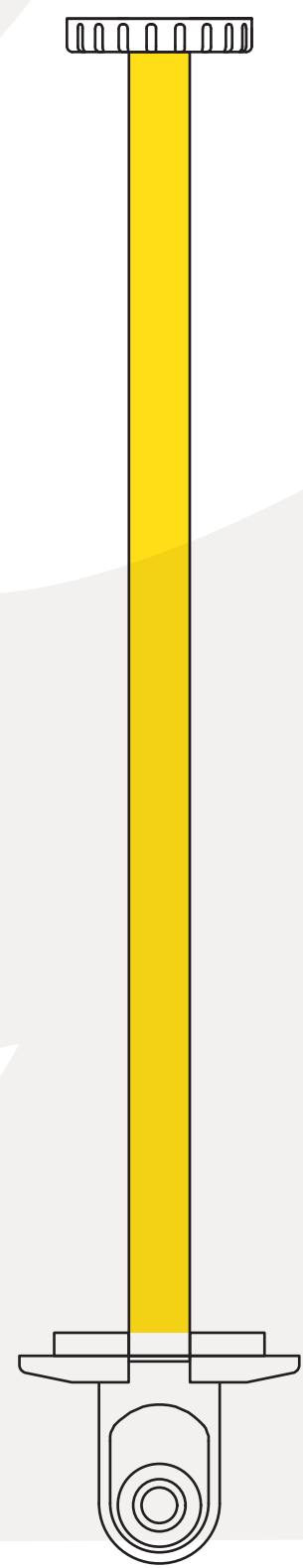

10"
254 mm

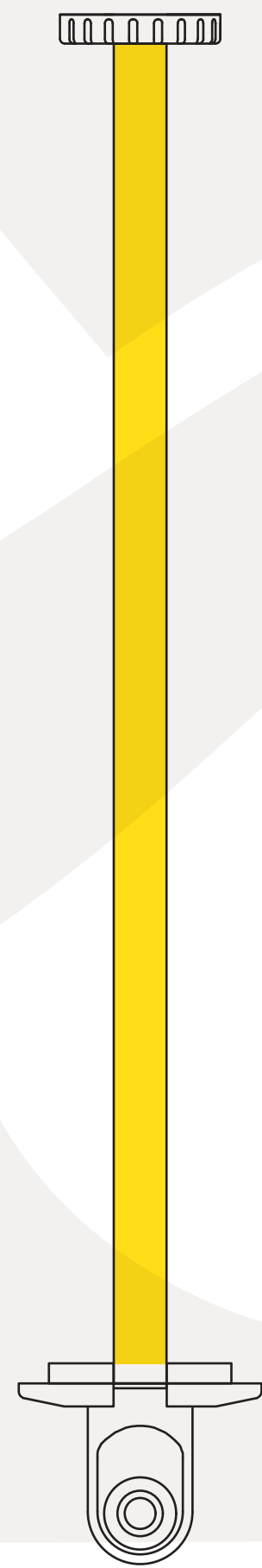

12"
304,8 mm

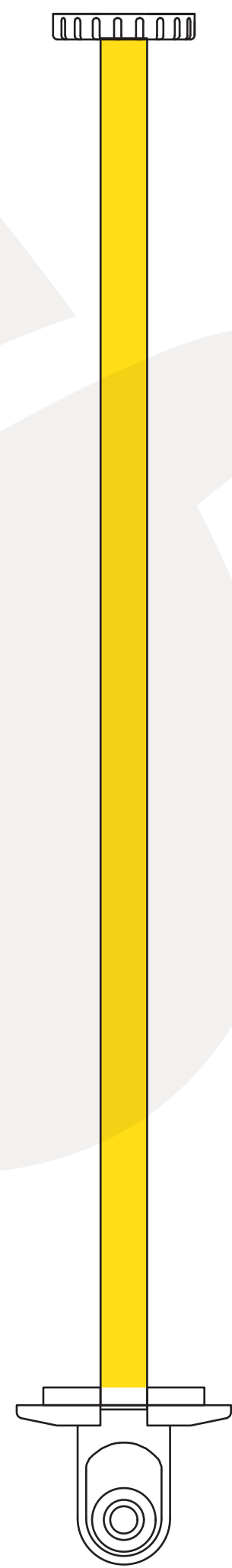

14"
355,6 mm

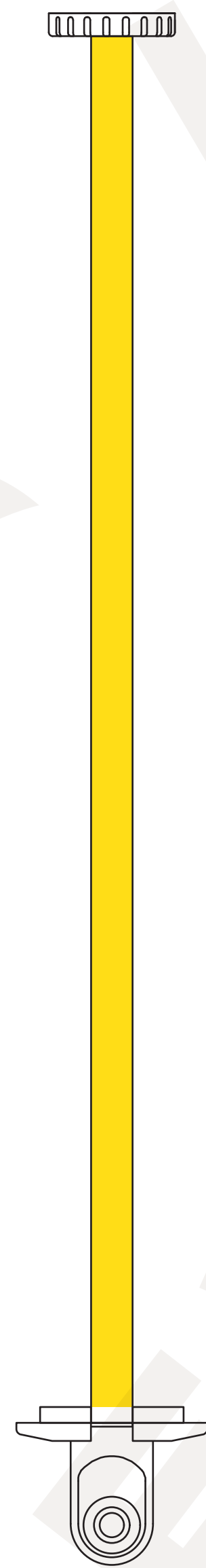

16"
406,4 mm

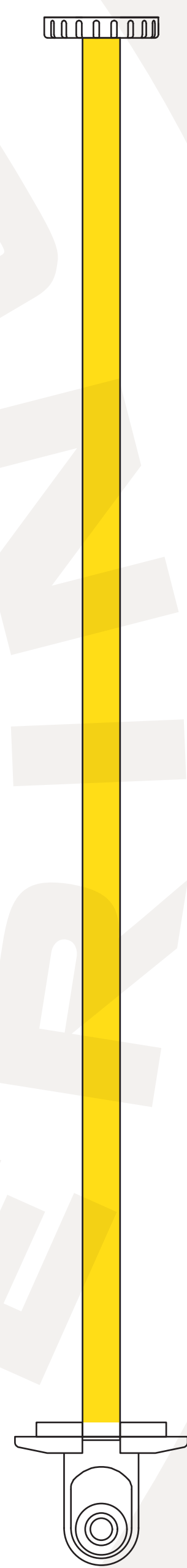

18"
457,2 mm



**EXCLUSIVE
DEALER**



Scale:
Not to Scale

Date:
2019

Powered by:
Graphic division Acerni C.E.

© Acerni Custom Engineering
Via Giovanni XXIII, 3
43040 - Varano de' Melegari
Tel +39 0525.53231
www.acerni.it

REGOLAZIONE ESTERNA COMPRESSIONE

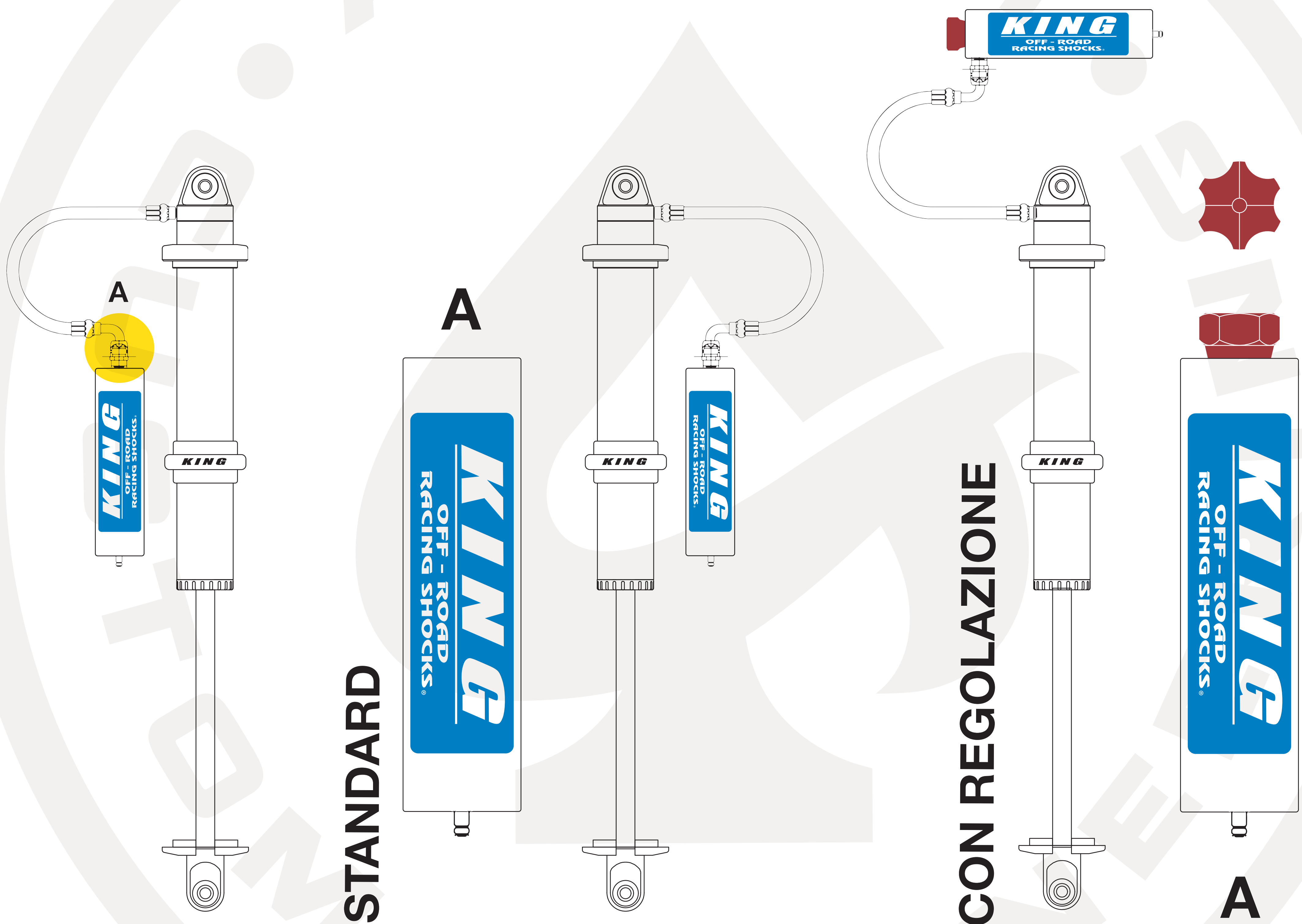

**EXCLUSIVE
DEALER**



Scale:
Not to Scale

Date:
2019

Powered by:
Graphic division Acerni C.E.

© Acerni Custom Engineering
Via Giovanni XXIII, 3
43040 - Varano de' Melegari
Tel +39 0525.53231
www.acerni.it

PIATTELLO MOLLA INFERIORE

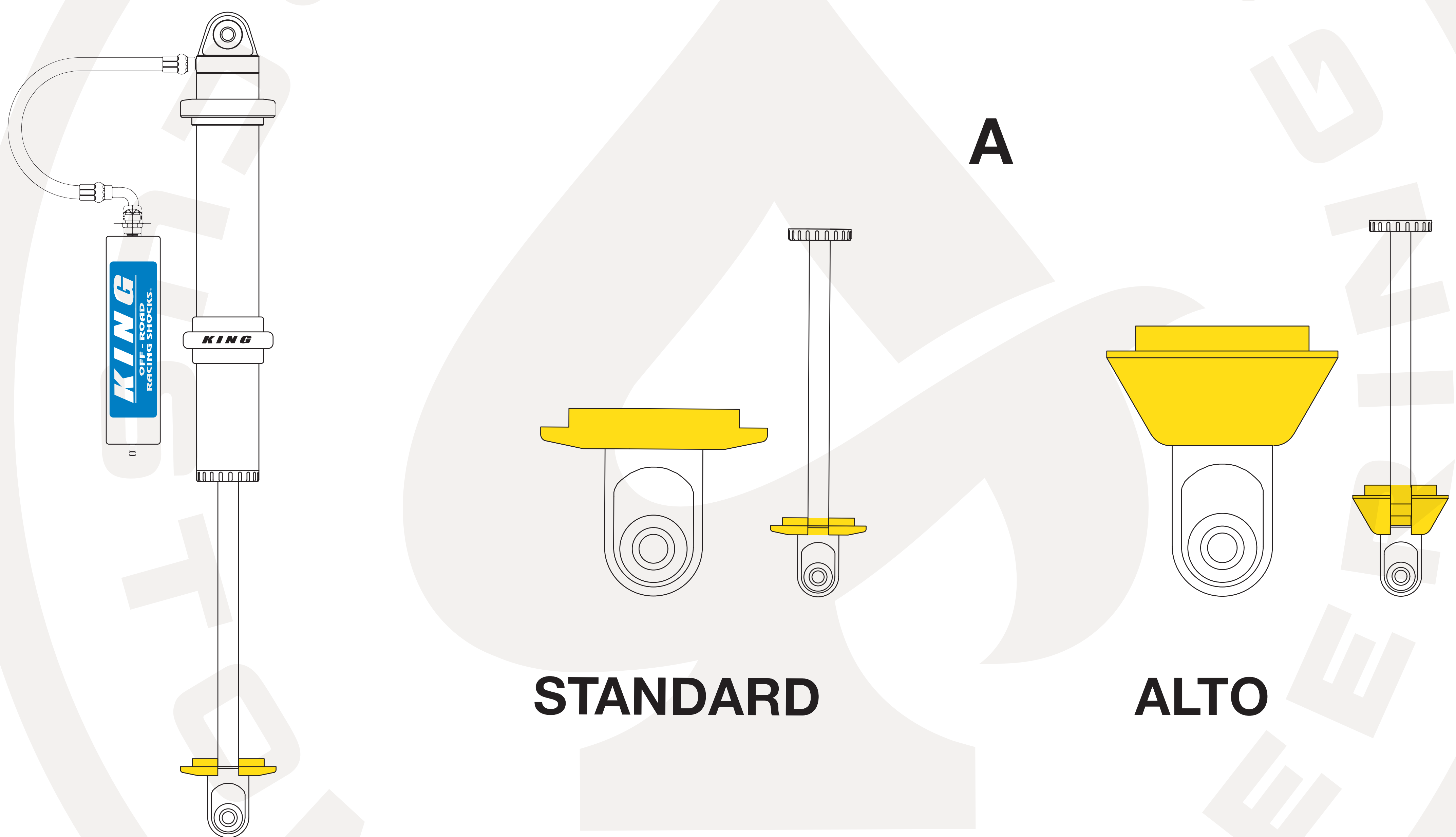

**EXCLUSIVE
DEALER**



Scale:
Not to Scale

Date:
2019

Powered by:
Graphic division Acerni C.E.

© Acerni Custom Engineering
Via Giovanni XXIII, 3
43040 - Varano de' Melegari
Tel +39 0525.53231
www.acerni.it

SLITTA CENTRALE

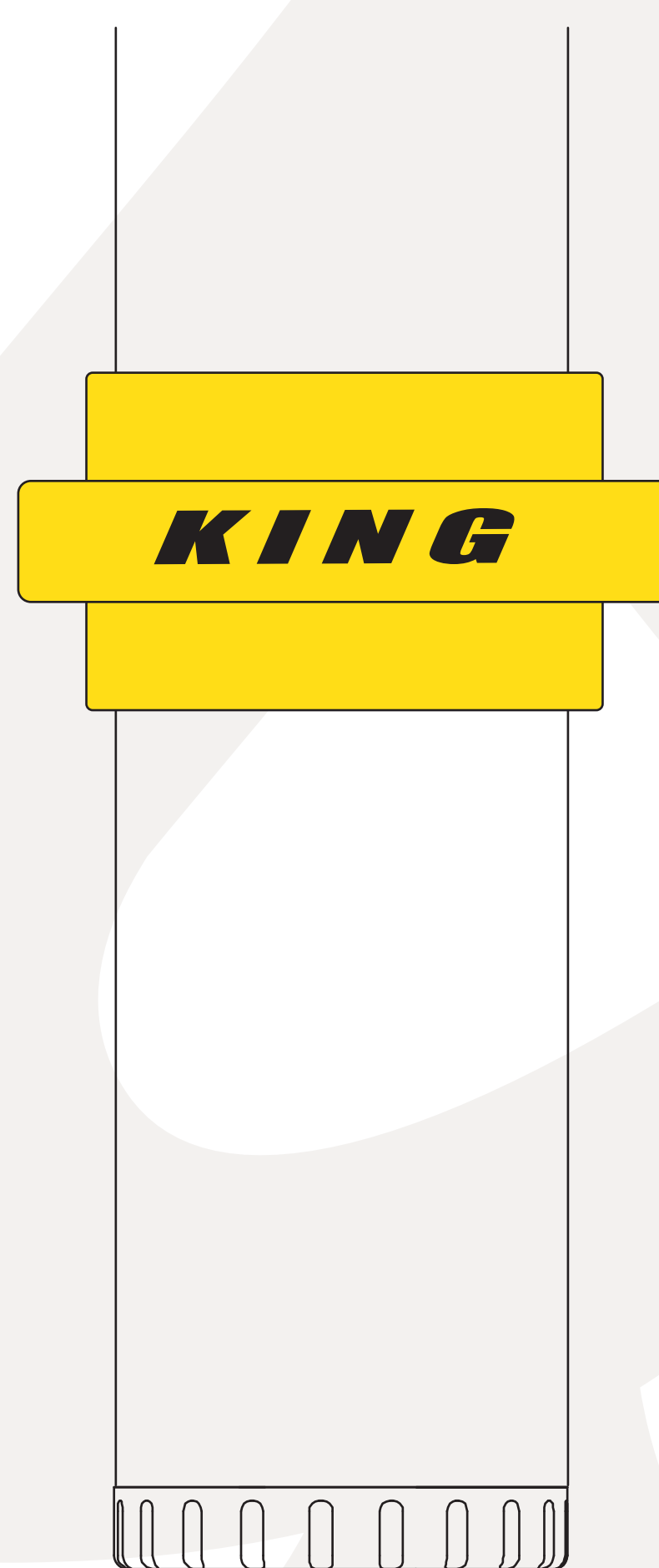
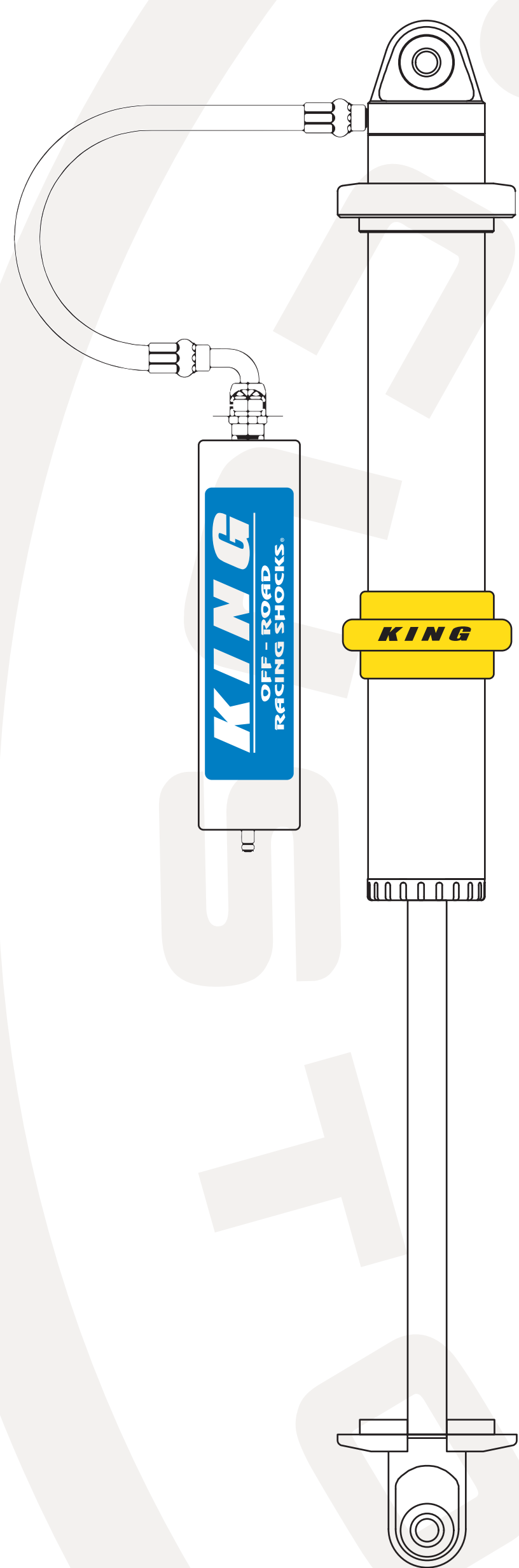

STANDARD

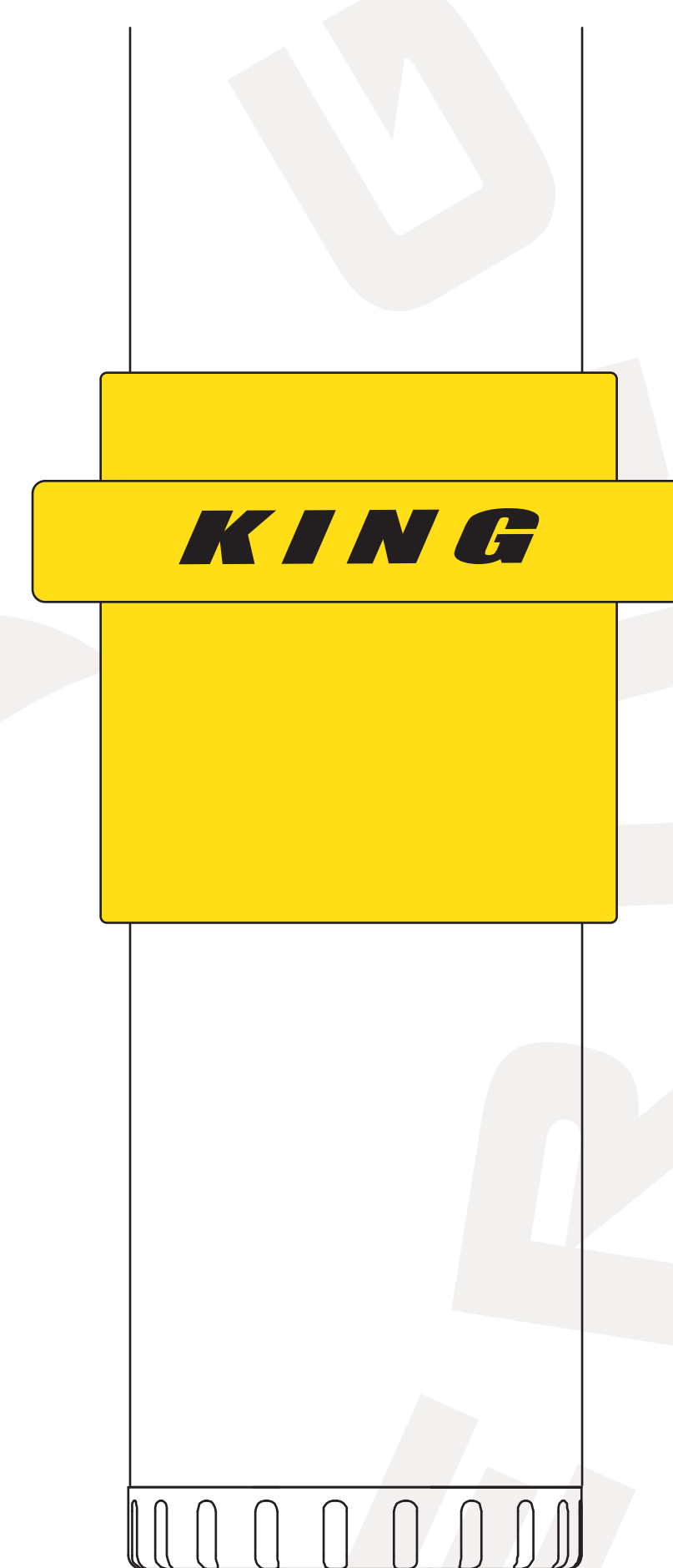

BILLET



**EXCLUSIVE
DEALER**



Scale:
Not to Scale

Date:
2019

Powered by:
Graphic division Acerni C.E.

© Acerni Custom Engineering
Via Giovanni XXIII, 3
43040 - Varano de' Melegari
Tel +39 0525.53231
www.acerni.it

LUNGHEZZA PIEDE

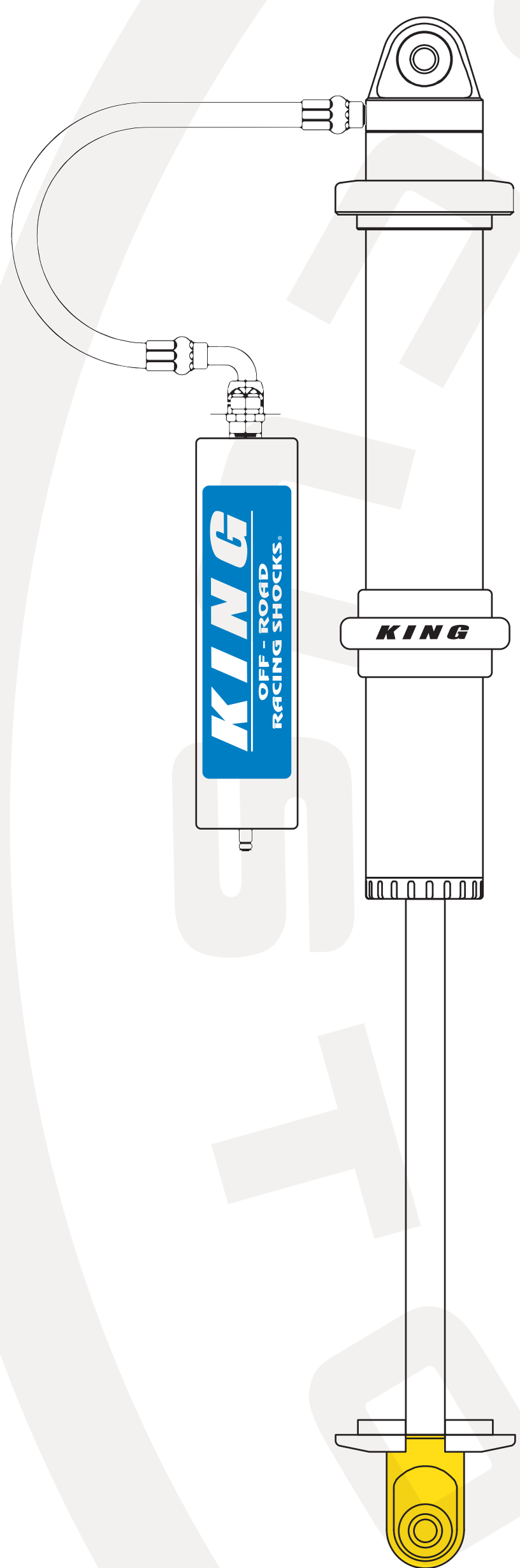

A

A

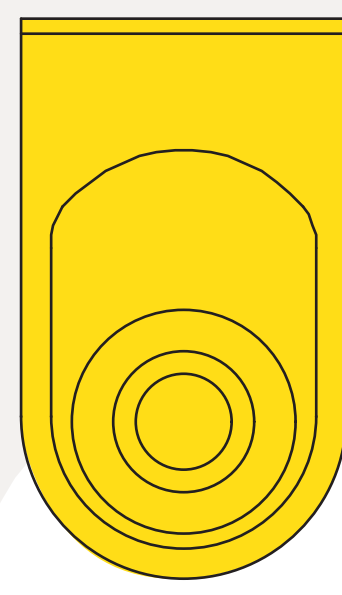

S. 3"
76,2 mm

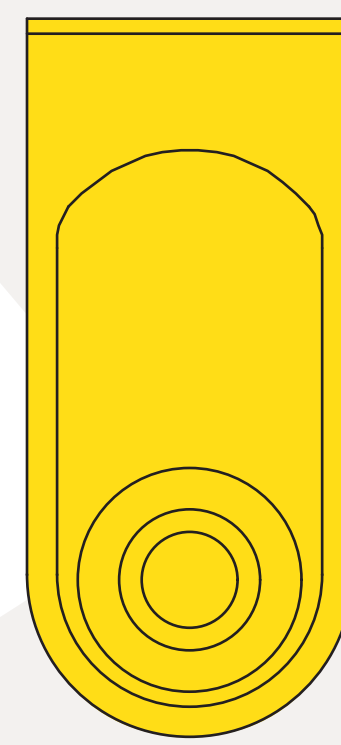

+1" = 4"
101,6 mm

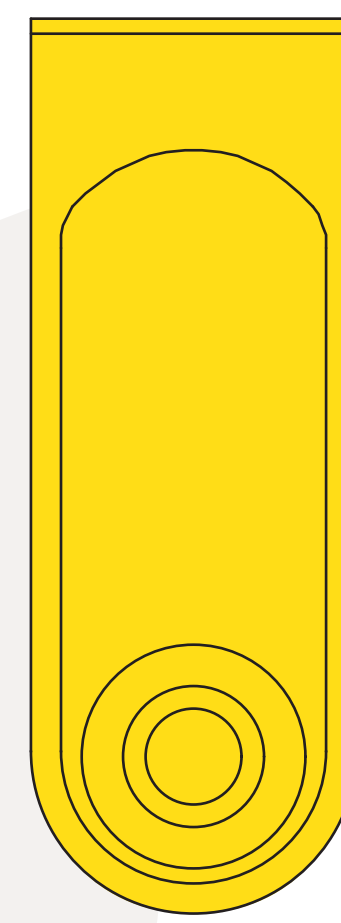

+2" = 5"
127,0 mm

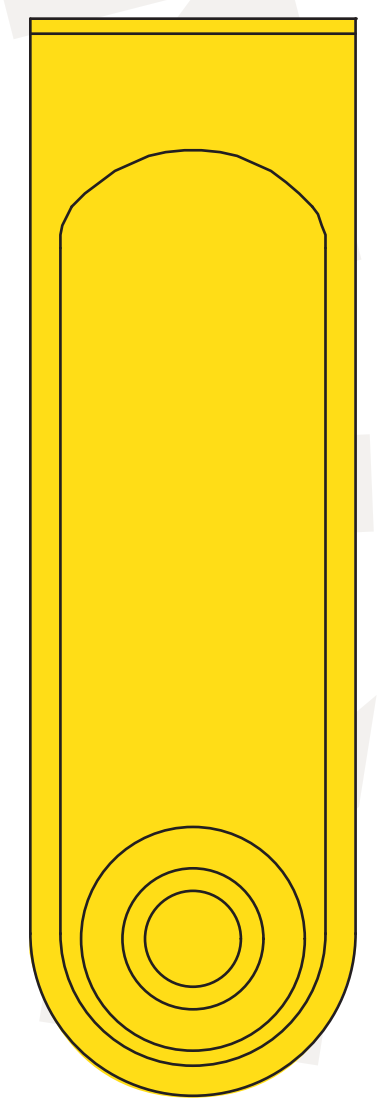

+3" = 6"
152,4 mm



**EXCLUSIVE
DEALER**



Scale:
Not to Scale

Date:
2019

Powered by:
Graphic division Acerni C.E.

© Acerni Custom Engineering
Via Giovanni XXIII, 3
43040 - Varano de' Melegari
Tel +39 0525.53231
www.acerni.it

SERBATOIO

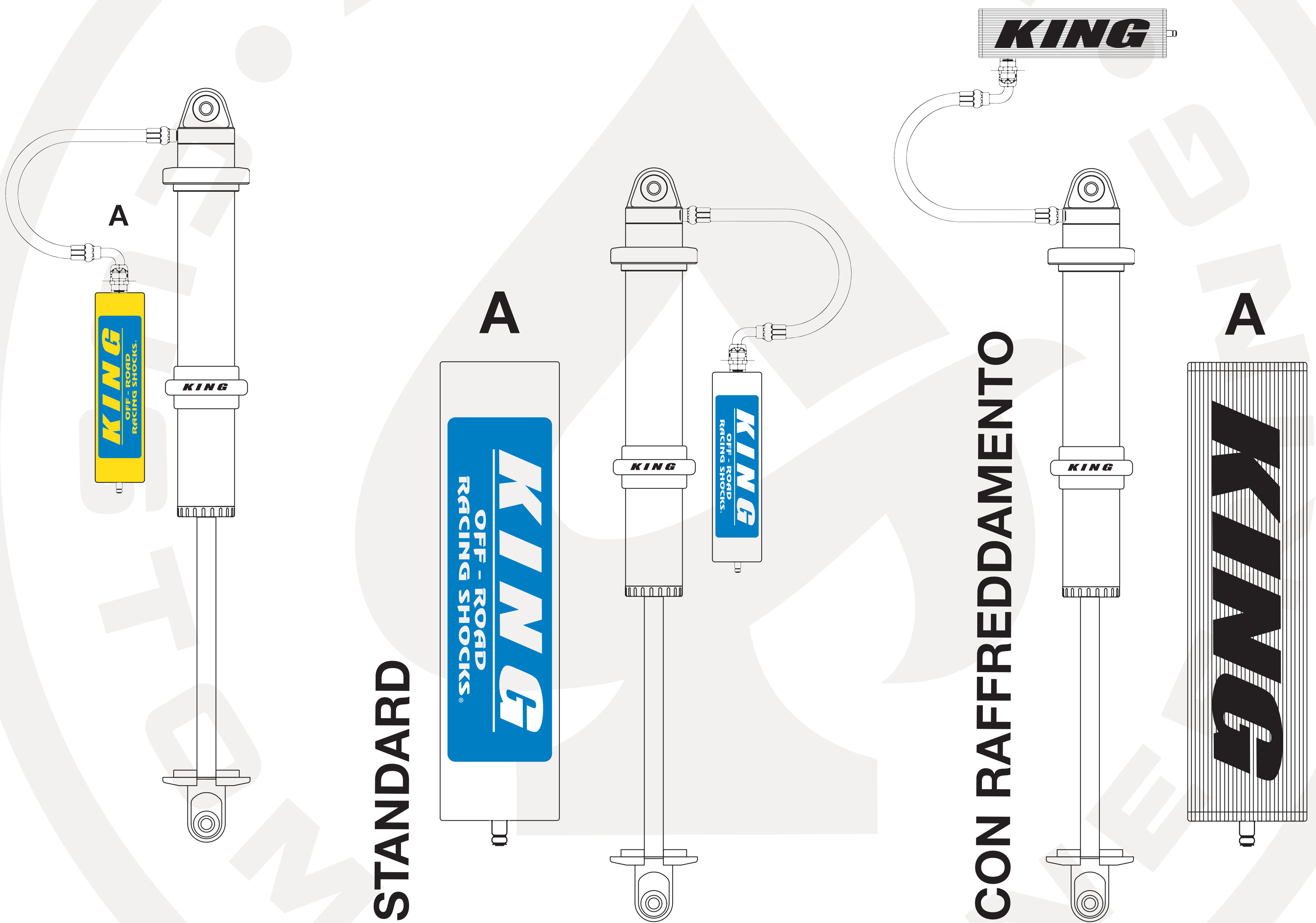

**EXCLUSIVE
DEALER**



Scale:
Not to Scale

Date:
2019

Powered by:
Graphic division Acerni C.E.

© Acerni Custom Engineering
Via Giovanni XXIII, 3
43040 - Varano de' Melegari
Tel +39 0525.53231
www.acerni.it

RACCORDO TUBO LATO AMMORTIZZATORE

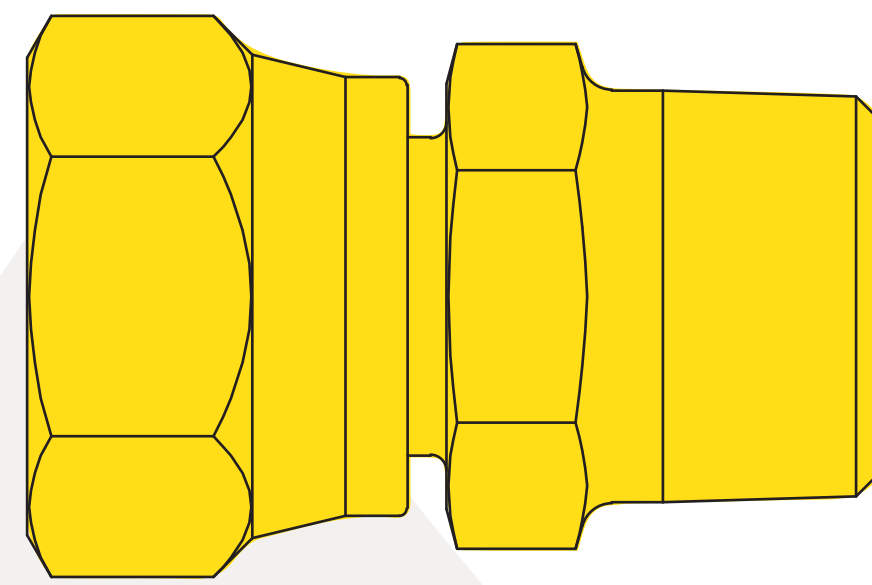
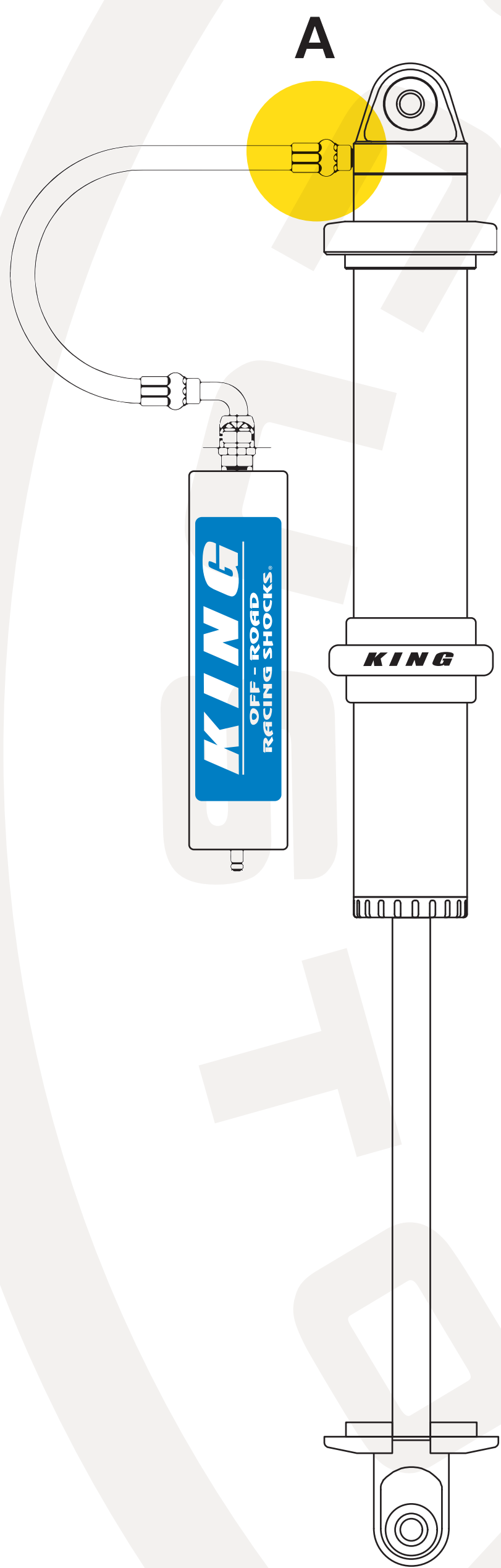

STANDARD

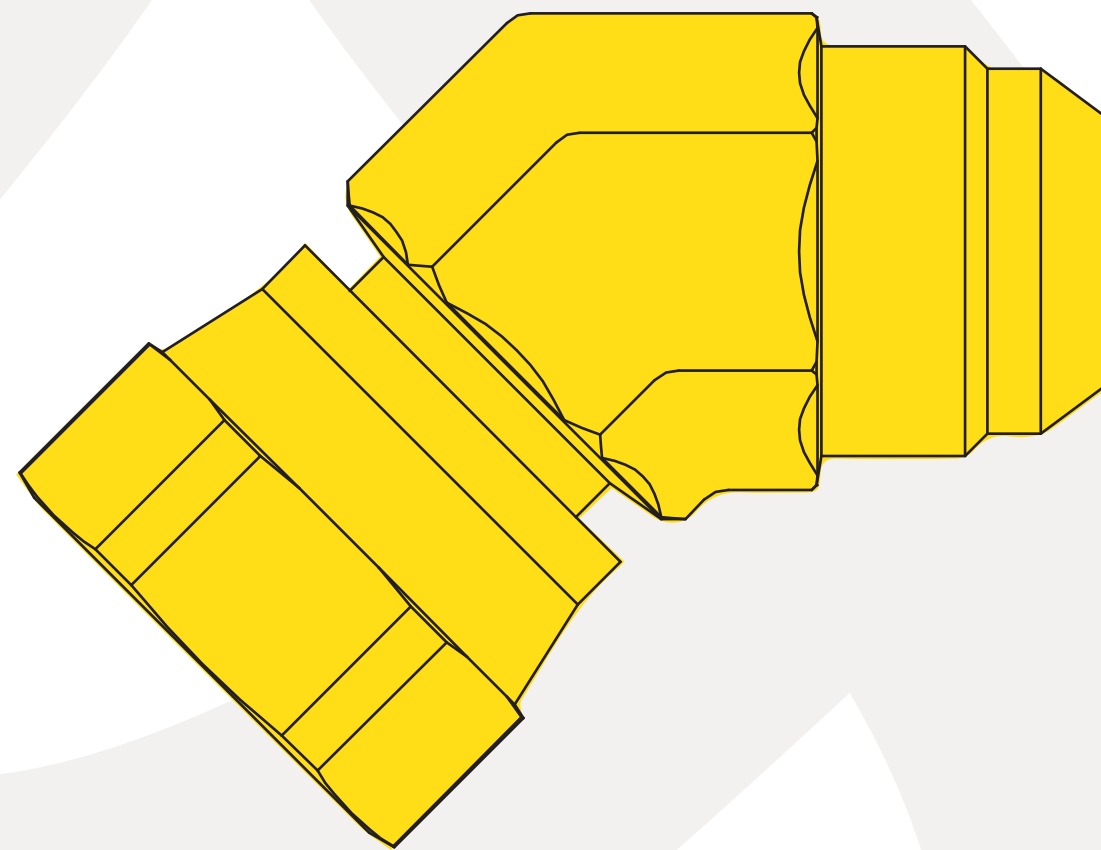

45°

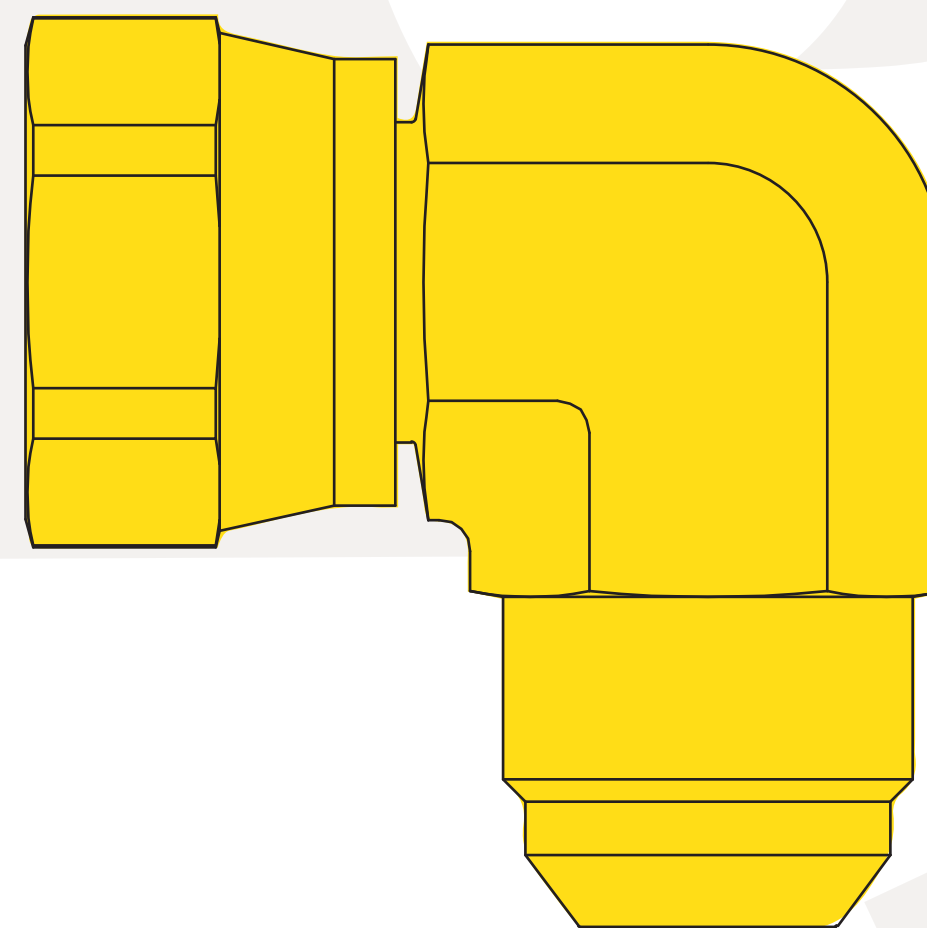

90°



**EXCLUSIVE
DEALER**



Scale:
Not to Scale

Date:
2019

Powered by:
Graphic division Acerni C.E.

© Acerni Custom Engineering
Via Giovanni XXIII, 3
43040 - Varano de' Melegari
Tel +39 0525.53231
www.acerni.it

RACCORDO TUBO LATO SERBATOIO

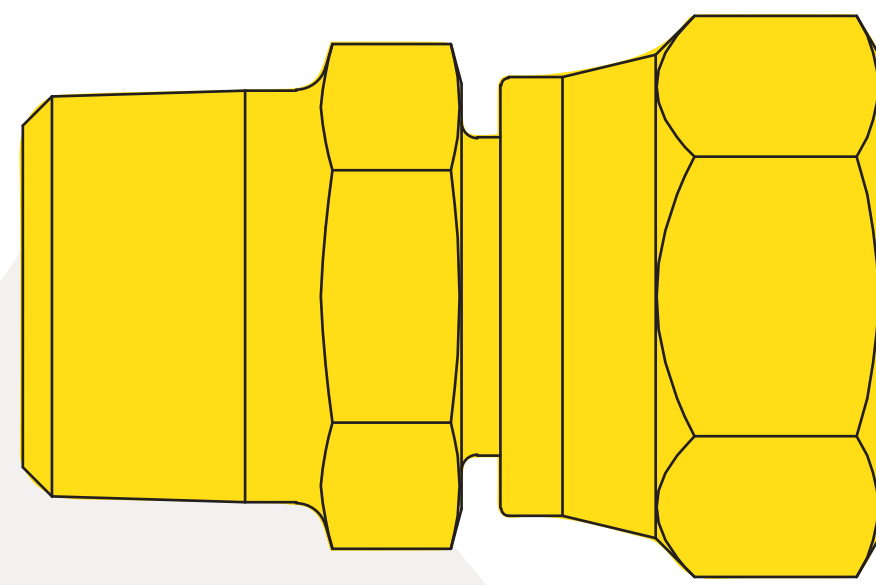
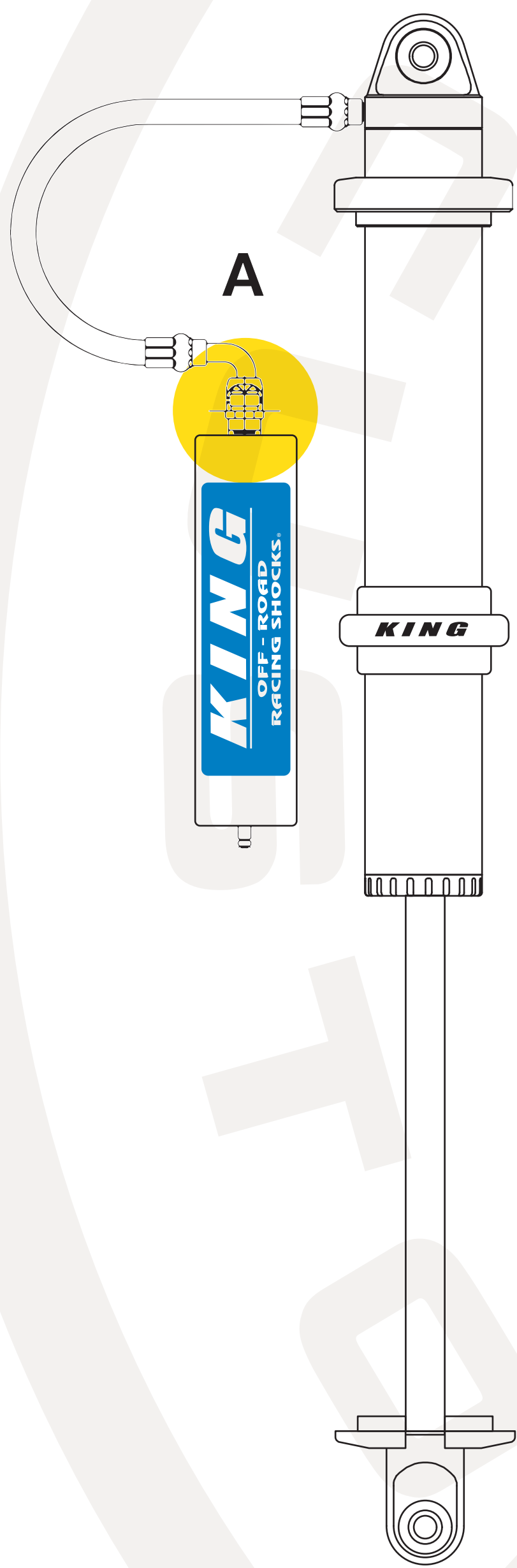

STANDARD

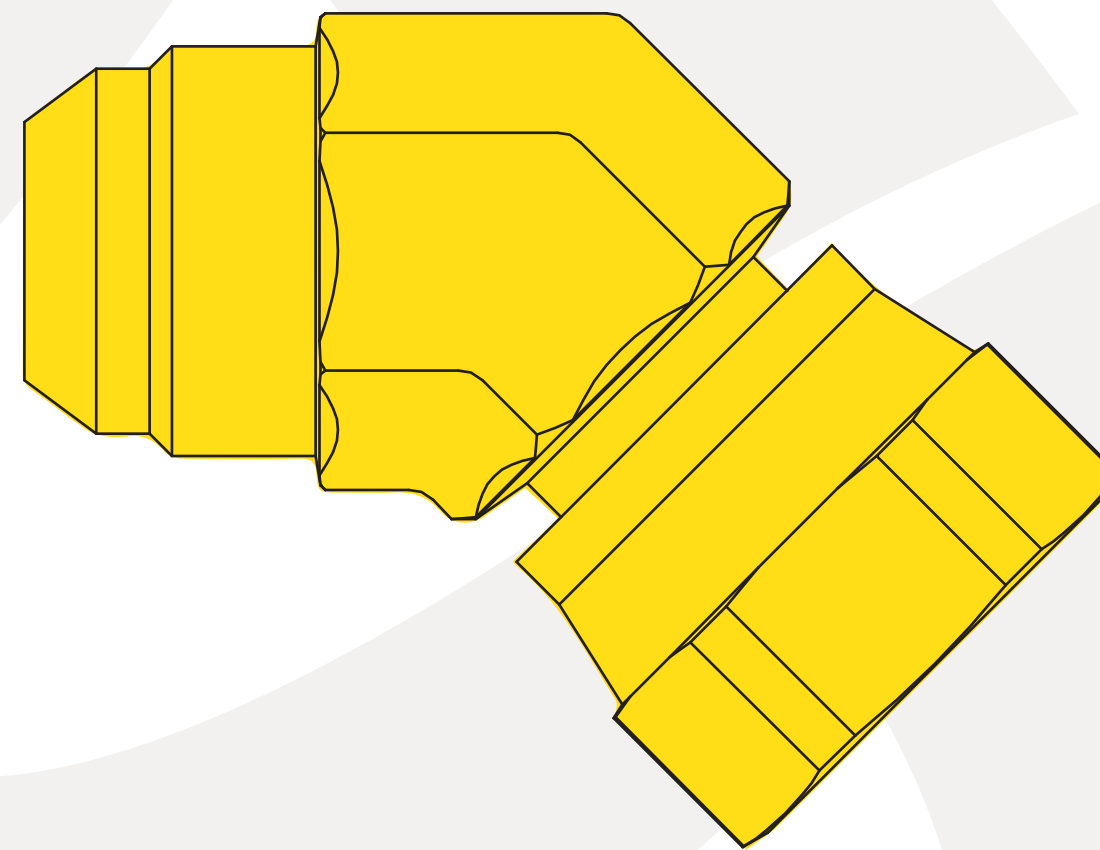

45°

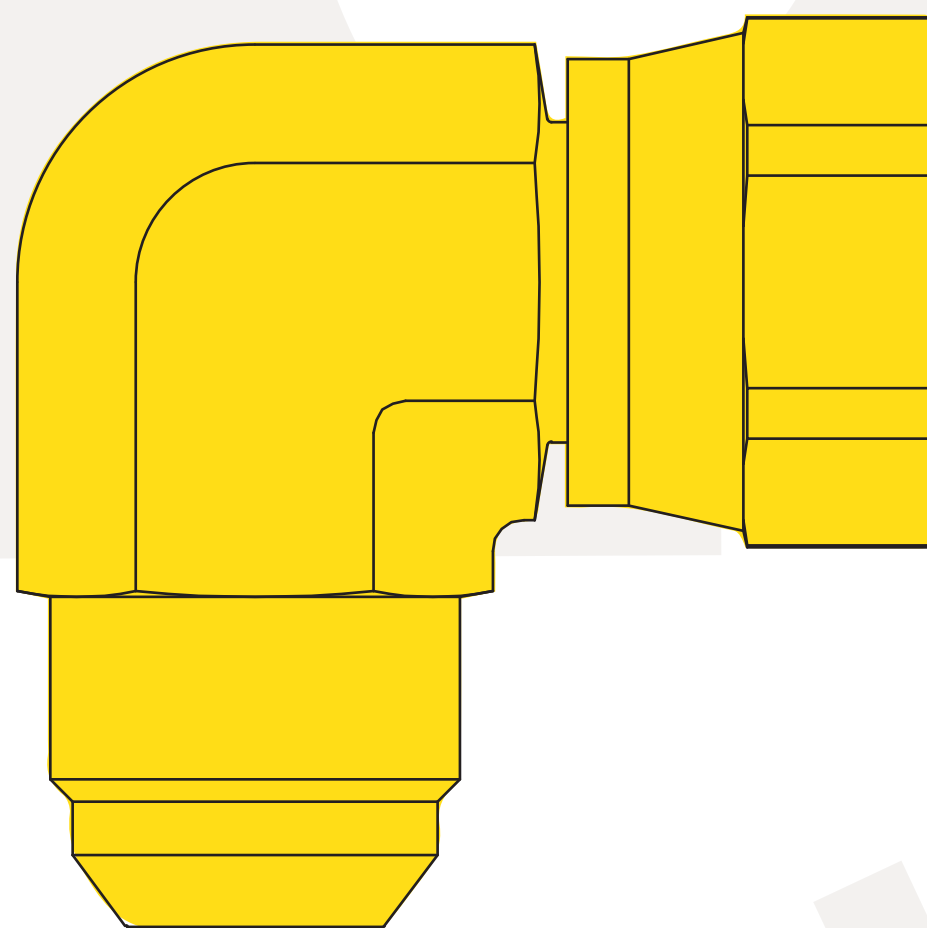

90°



**EXCLUSIVE
DEALER**



Scale:
Not to Scale

Date:
2019

Powered by:
Graphic division Acerni C.E.

© Acerni Custom Engineering
Via Giovanni XXIII, 3
43040 - Varano de' Melegari
Tel +39 0525.53231
www.acerni.it

FINE CORSA ESTERNO

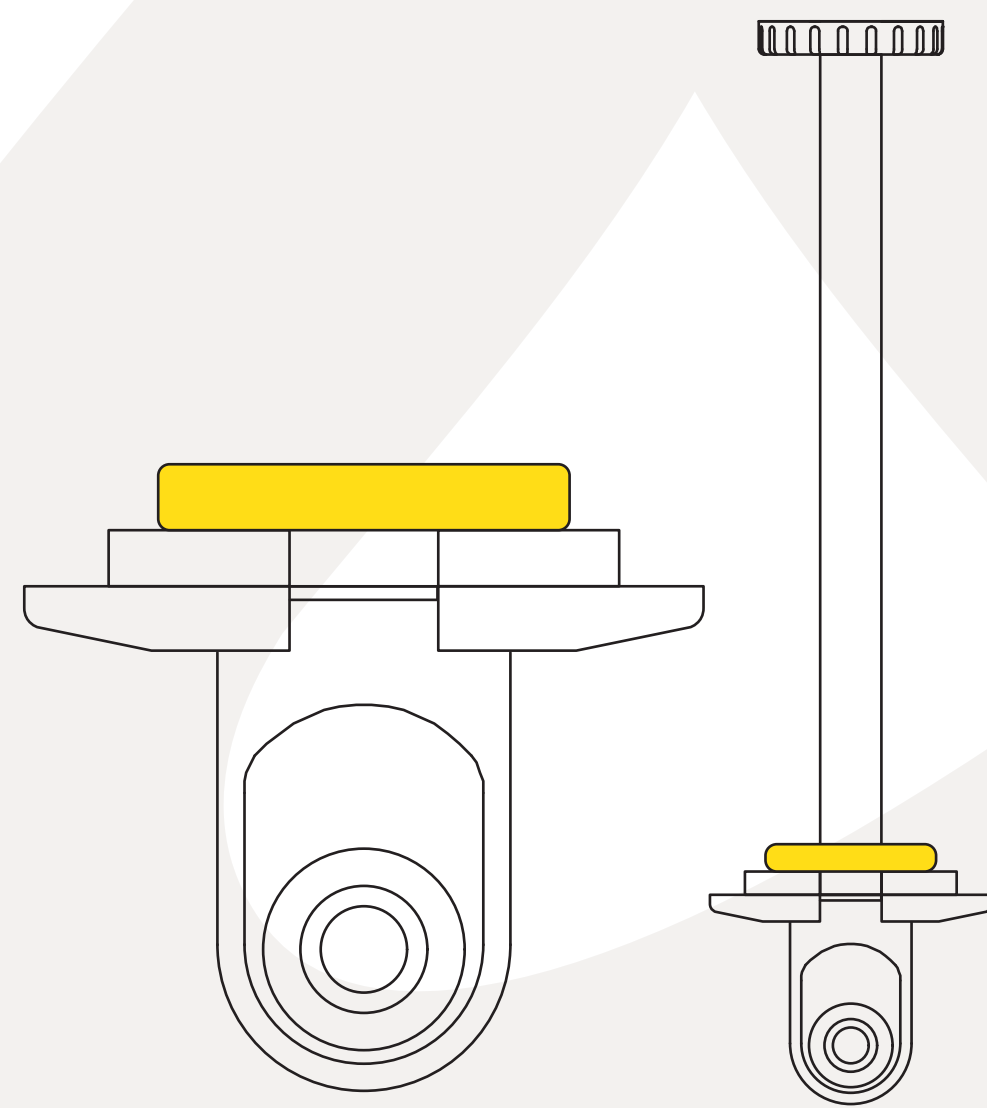
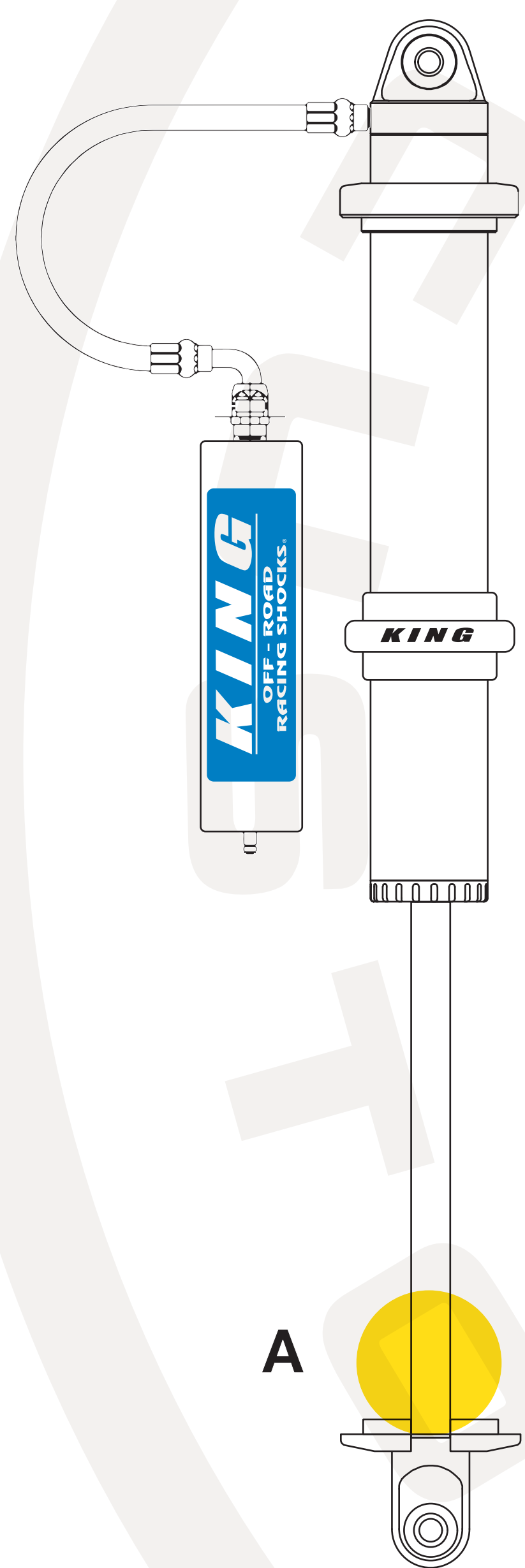

STANDARD

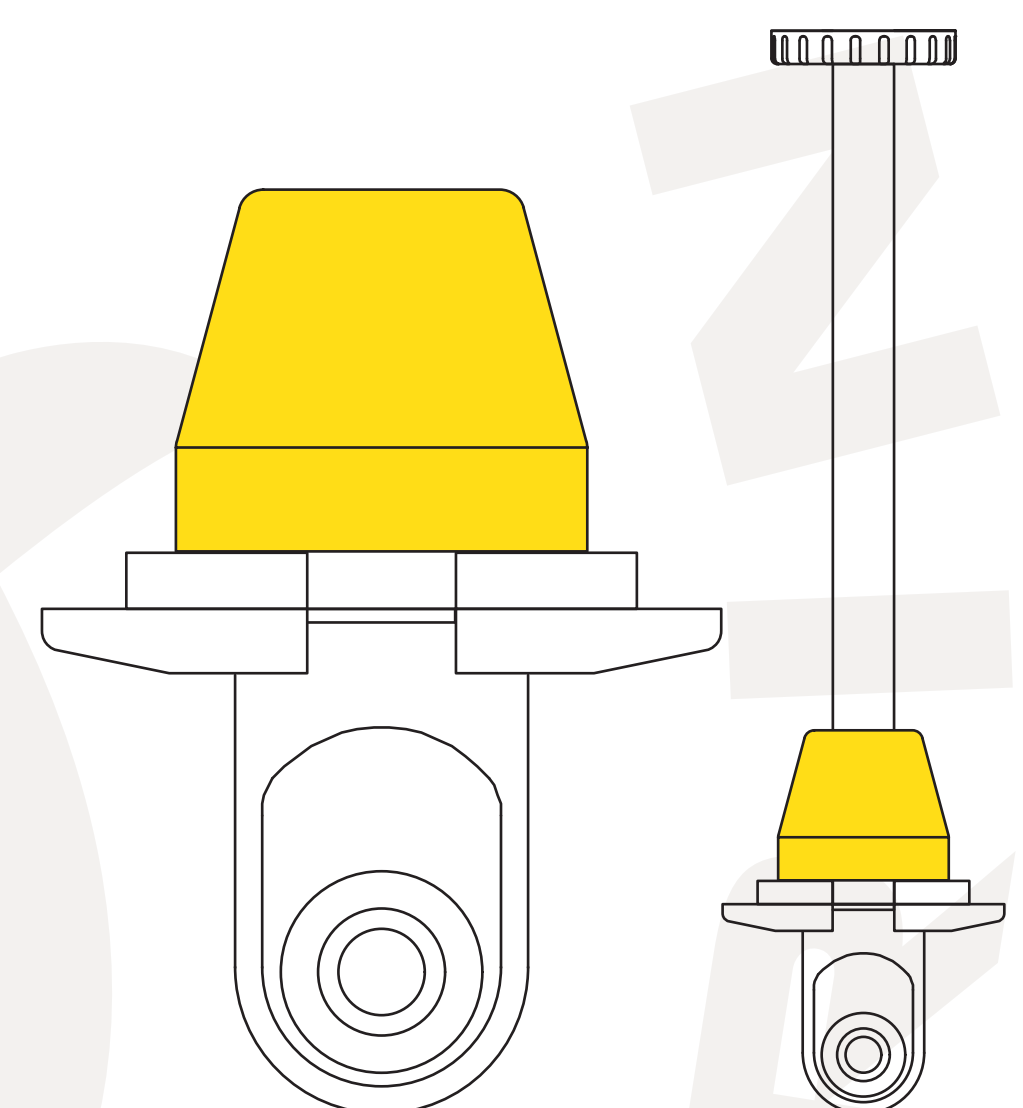

FOAM



**EXCLUSIVE
DEALER**



Scale:
Not to Scale

Date:
2019

Powered by:
Graphic division Acerni C.E.

© Acerni Custom Engineering
Via Giovanni XXIII, 3
43040 - Varano de' Melegari
Tel +39 0525.53231
www.acerni.it

SPESSORI FISSAGGIO

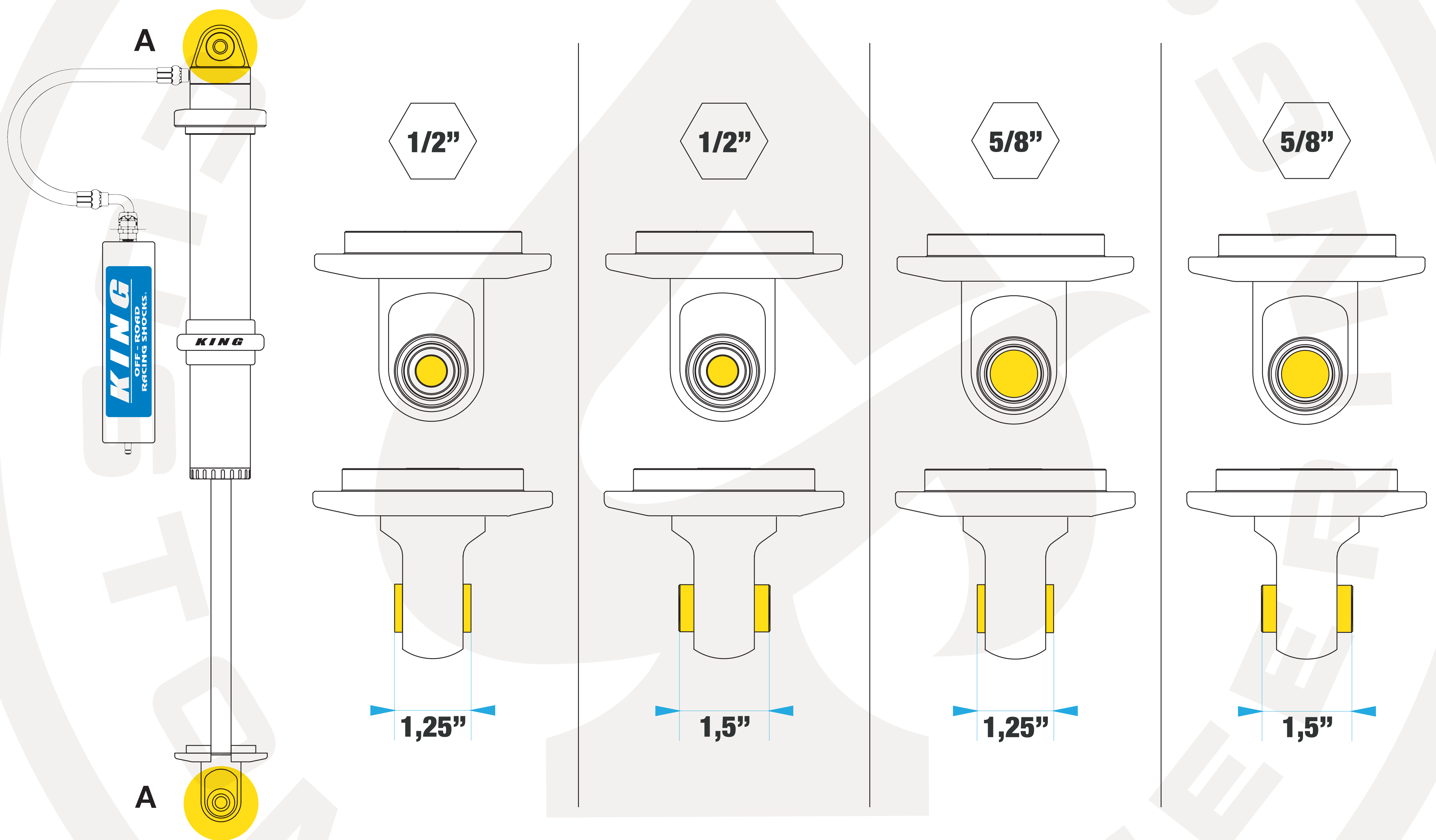

**EXCLUSIVE
DEALER**



Scale:
Not to Scale

Date:
2019

Powered by:
Graphic division Acerni C.E.

© Acerni Custom Engineering
Via Giovanni XXIII, 3
43040 - Varano de' Melegari
Tel +39 0525.53231
www.acerni.it